

Form 20579
(552)

ADJUSTERS MANUAL
for
SINGER*
ELECTRIC SEWING MACHINE 301

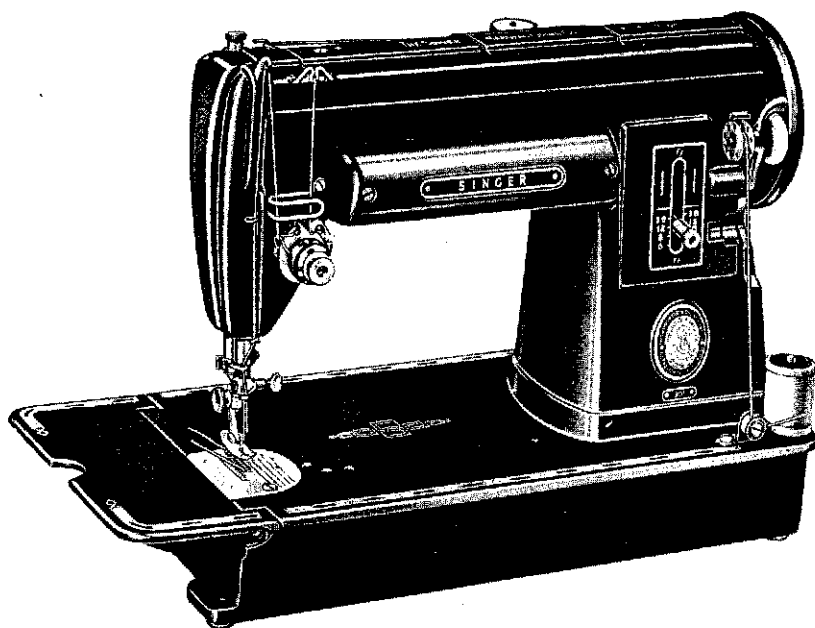

Machine 301-1

THE SINGER MANUFACTURING COMPANY

Printed in U.S.A.

INDEX

	<u>Page</u>
Arm Shaft, adjusting for correct end play.	10
Bobbin Winder, removing and replacing.	11
Feed Dog, adjusting height of.	9
Feed Dog, adjusting lengthwise in throat plate slots	9
Feed Throw-out, regulating	10
Gears, adjusting for correct end play.	5
Gears, adjusting for correct mesh.	11
Hand Wheel, removing and replacing	8
Motor, removing and replacing	3
Motor, wiring of	12
Needle Bar, setting at correct height.	6
Needle Bar Bushing, setting in relation to needle bar.	6
Presser Foot, adjusting height of.	4
Rotating Hook, removing and replacing (without affecting timing)	7
Rotating Hook, timing of	5 and 6
Rotating Hook Shaft, replacing	7 and 8
SINGERLIGHT, removing and replacing socket	4
SINGERLIGHT, wiring of	12
Wiring Diagram of Machine 301-1.	12

*A Trade Mark of THE SINGER MANUFACTURING COMPANY

Copyright, U. S. A., 1951 and 1952, by The Singer Manufacturing Company
All Rights Reserved for all Countries

ADJUSTERS MANUAL

for

SINGER

ELECTRIC SEWING MACHINE 301

TO REMOVE AND REPLACE MOTOR

To remove motor:

1. Tilt machine back on its rear side
2. Remove bottom cover plate
3. Remove motor hold down plate by removing screw from A, Fig. 1
4. Remove two electrical sleeve connections B, Fig. 1 from motor terminals C, Fig. 1
5. Slide motor out toward you, rocking motor from side to side to facilitate removal

NOTE: Fig. 1 shows grease tube X3 as it appears on motor of machines now leaving the factory. In the past, some machines have been sent out with motor grease tube located diametrically opposite the one illustrated in Fig. 1.

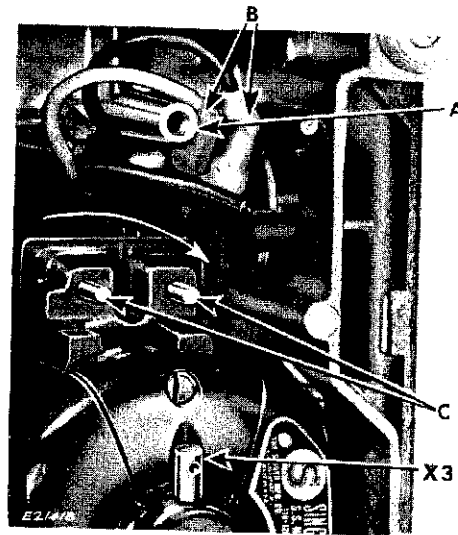

Fig. 1. Removing and Replacing Motor

To replace motor:

Make sure that wire D4, Fig. 2 is properly located in order to prevent motor from rubbing or chafing against wire. Fig. 2 shows wire properly located around and under cylindrical tube D, Fig. 2 and up and behind three pin terminal E, Fig. 2.

1. Slide motor into position, turning hand wheel slightly to ensure proper gear mesh. Be sure motor is properly positioned by pushing motor clockwise until motor butts against casting as shown by curved arrow in Fig. 1.
2. Fit electrical sleeve connections B, Fig. 1 over terminals C, Fig. 1
3. Replace motor hold down plate and bottom cover plate

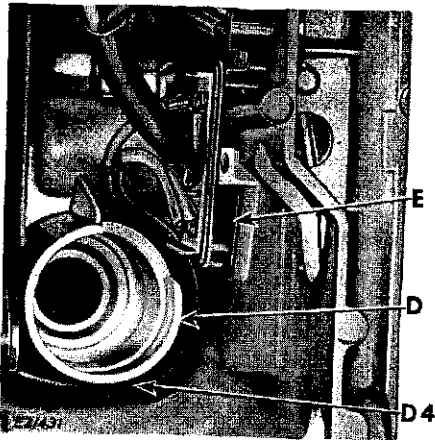

Fig. 2. Location of Wires around Motor

TO REMOVE AND REPLACE SINGERLIGHT* SOCKET

To remove SINGERLIGHT socket:

1. Remove top cover of machine
2. Remove oil shield E3, Fig. 3 to obtain access to wire connections, unscrew two wire connectors and untwist wires at F, Fig. 3
3. Remove SINGERLIGHT lamp shade and lens
4. Remove set screw G, Fig. 4
5. Remove light socket and its wires by passing wires down through rubber grommet H, Figs. 3 and 4

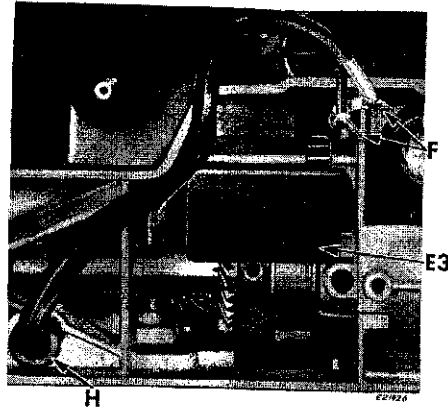

Fig. 3. Removing SINGERLIGHT Wires

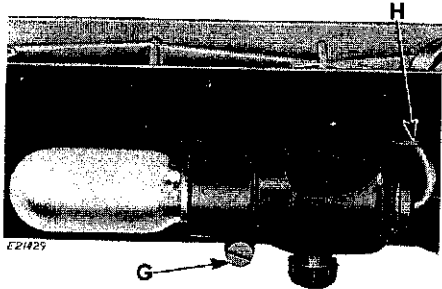

Fig. 4. Removing SINGERLIGHT Socket

To replace SINGERLIGHT socket:

Reverse above procedure. See wiring diagram on page 12 for correct wire connections.

TO ADJUST HEIGHT OF PRESSER FOOT

IMPORTANT: If presser foot height is too high or too low, the attachments for this machine will not fit properly on the presser bar.

To adjust presser foot to correct height:

1. Raise presser bar lifter F3, Fig. 5
2. Loosen set screw G3, Fig. 5 behind face plate
3. Move presser bar up or down, as required, until the bottom of the presser foot is .295" above the top surface of the throat plate, as shown in Fig. 5
4. Tighten the set screw G3, Fig. 5

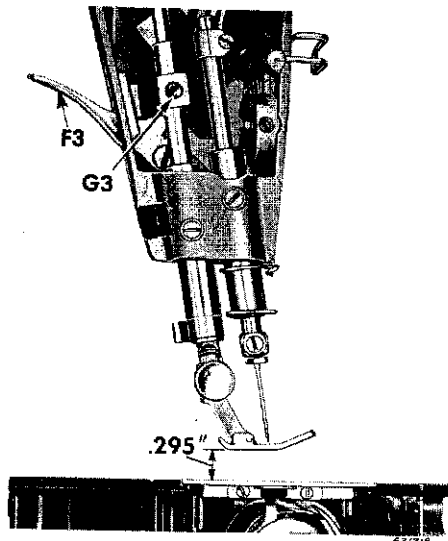

Fig. 5. Adjusting Presser Foot Height

- 5 -
TO TIME ROTATING HOOK

1. Remove presser foot and throat plate. (Feed dog has been removed in Figs. 6 and 7 for clearer view, but it need not be removed to time rotating hook.)
2. Turn hand wheel over toward you until lower timing mark J, Fig. 6 on needle bar is aligned with lower end of the needle bar bushing at K on upward stroke of needle bar
3. If needle bar is at correct height and in position described in paragraph 2 above, and if hook is correctly timed, then point of hook should be at center of needle and approximately 1/16" above eye of needle as shown at L, Fig. 7. Gib H3 of rotating hook is shown broken away and bobbin case base is moved around so that position finger J3 is out of the way in Fig. 7 for clearer view of needle and point of hook.

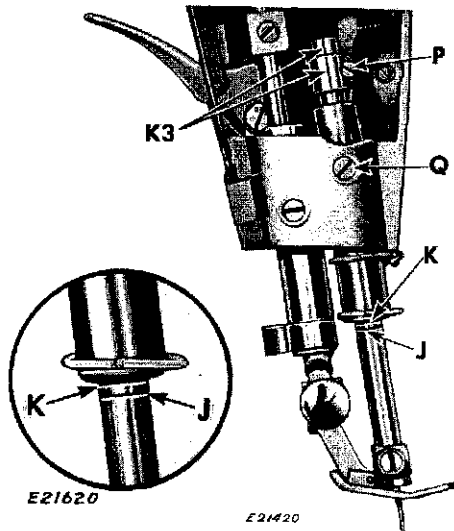

Fig. 6. Timing Rotating Hook

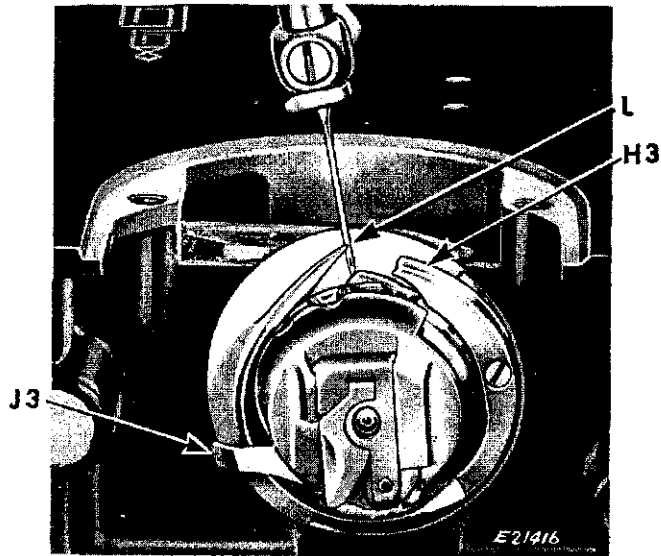

Fig. 7. Relation of Needle to Rotating Hook

If hook is not correctly timed,

1. Remove bottom cover plate
2. Loosen two set screws M, Fig. 8 in gear at right hand end of hook shaft
3. Turn hook until its point is in proper relation to needle as explained above and shown in Fig. 7
4. Tighten two screws M, Fig. 8, maintaining proper backlash to ensure correct gear mesh

NOTE: Hub of gear should never bear against face of bushing at N, Fig. 8

5. Replace bottom cover plate

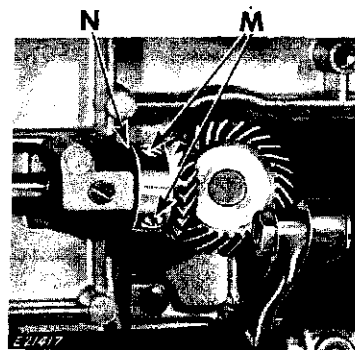

Fig. 8. Adjusting Gears For Correct End Play

TO SET NEEDLE BAR AT CORRECT HEIGHT

To set needle bar at the correct height, the rotating hook must first be timed correctly as described on page 5. Then turn the hand wheel over toward you until the needle bar reaches its lowest point as shown in Fig. 6. With the needle bar in this position, the upper timing mark should be in alignment with the lower end of the needle bar bushing as shown at K, Fig. 6.

If the needle bar is not set at the correct height, loosen the screw P, Fig. 6 behind the face plate and move the needle bar up or down until the correct setting is acquired and then securely tighten the screw P.

The needle bar bushing is accurately set at the factory and needs no adjustment. If its position has been disturbed, however, turn the hand wheel over toward you until the point of the hook, on the upward stroke of the needle bar, is at the center of the needle and approximately 1/16" above the eye of the needle as shown in Fig. 7. Loosen the bushing set screw Q, Fig. 6 and move the bushing up or down until the lower timing mark J, Fig. 6 on the needle bar aligns with the lower end of the bushing at K, Fig. 6. Then tighten the set screw Q.

TO SET NEEDLE BAR, NEEDLE BAR BUSHING AND ROTATING HOOK WHEN ALL ARE OUT OF TIME

1. Adjust the needle bar bushing until the recess in the bushing is visible through the set screw hole for the screw Q, Fig. 6.
2. Turn the hand wheel over toward you until the needle bar is at the lowest point of its stroke
3. Loosen the clamp screw P, Fig. 6 of the needle bar
4. Adjust the needle bar so that the upper timing mark aligns with the bottom of the needle bar bushing as shown at K, Fig. 6, then tighten the needle bar clamp screw P, Fig. 6
5. Loosen the gear screws M, Fig. 8
6. Turn the hand wheel over toward you so that, on the upward stroke of the needle bar, the lower timing mark J, Fig. 6 aligns with the bottom of the needle bar bushing at K, Fig. 6
7. Rotate the hook manually until the hook point is at the center of the needle blade as shown at L, Fig. 7, and then tighten the gear screws M, Fig. 8
8. Turn the hand wheel over toward you until the hook point is at the center of the needle (on the upward stroke of the needle bar) and the lower timing mark aligns with the bottom of the needle bar bushing. (This is to serve as a check on operation 7 above.) Loosen the needle bar clamping screw P, Fig. 6 and move the needle bar up or down until the eye of the needle is approximately 1/16" below the point of the hook. Turn the needle bar until the positioning marks K3, Fig. 6 on the needle bar and the needle bar clamp are in alignment. Tighten the screw P in the needle bar clamp.
9. Turn the hand wheel over toward you until the needle bar reaches its lowest position
10. Loosen the needle bar bushing set screw Q, Fig. 6 and move the bushing up or down until the bottom of the bushing aligns with the upper timing mark on the needle bar as shown at K, Fig. 6, and tighten the screw Q

Shaft replacement should be made without disengaging teeth of gears. By following the instructions on the previous page, gears will keep in mesh during replacement of shaft. The correct location of shaft with relation to rotating hook is determined as follows:

1. Set and tighten screw T, Fig. 9 of collar so that left hand end of shaft projects $15/32$ " beyond left hand edge of collar
2. Take out end play by setting counterbalance against bushing at X, Fig. 9, pushing collar and counterbalance toward each other, and tightening screw U, Fig. 9 in counterbalance
3. Replace rotating hook on shaft, with set screw R, Fig. 9 (which is on same side of hub as hook point) against flat of hook shaft. Then, while keeping hub of hook against shaft collar, tighten screw R, Fig. 9 which engages flat and then tighten screw on other side of hub. Set gear at right hand end of shaft with clearance between gear hub and bushing, and tighten two screws M, Fig. 8
4. Be sure to time rotating hook as instructed on page 5

IMPORTANT: The gears of this machine are properly meshed when machine leaves factory and they should not be disturbed for any reason.

TO REMOVE AND REPLACE HAND WHEEL

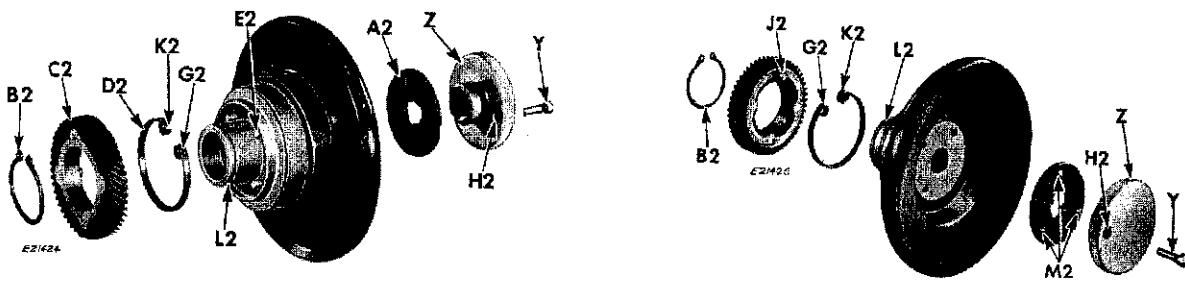

Figs. 11 and 12. Hand Wheel Assembly

To remove and disassemble hand wheel:

1. Remove small screw Y, stop motion nut Z and clamp washer A2, Figs. 11 and 12
2. Remove hand wheel snap ring B2 by means of expansion pliers
3. Lift off hand wheel gear C2
4. Lift hand wheel gear spring D2 off stud E2 in hand wheel

To reassemble and replace hand wheel:

1. Place gear spring D2 into hand wheel so that loop G2 of spring fits over middle stud E2 in hand wheel
2. Place hand wheel gear C2 on hand wheel so that stud J2 of gear fits into loop K2 of gear spring
3. Replace snap ring B2 so that it fits into groove L2 in sleeve of hand wheel
4. Replace hand wheel assembly on arm shaft of machine
5. Replace stop motion clamp washer A2 so that the three short studs M2 are facing outward (away from machine)
6. Replace and tighten stop motion nut Z and replace screw Y in hole H2

NOTE: If studs M2 interfere with screw Y when stop motion nut Z is loosened to release hand wheel from the stitching mechanism, then remove screw Y and stop motion nut Z, remove washer A2, rotate it 180° and replace it, and replace nut Z and screw Y

TO REMOVE AND REPLACE ROTATING HOOK
(without affecting timing)

To remove rotating hook:

1. Remove presser foot, throat plate and bottom cover plate
2. Loosen two screws, only one of which is visible at R, Fig. 9 in hub of hook
3. Remove rotating hook from shaft

To replace rotating hook:

1. Turn hand wheel over toward you until flat on hook shaft is visible through opening S, Fig. 9
2. Place hook on shaft so that set screw R, Fig. 9, on same side of hub as point of hook, is set on flat of hook shaft
3. Then, with hub of hook against shaft collar, tighten screw R which engages flat, and then tighten second screw on hub
4. Replace bottom cover plate, throat plate and presser foot

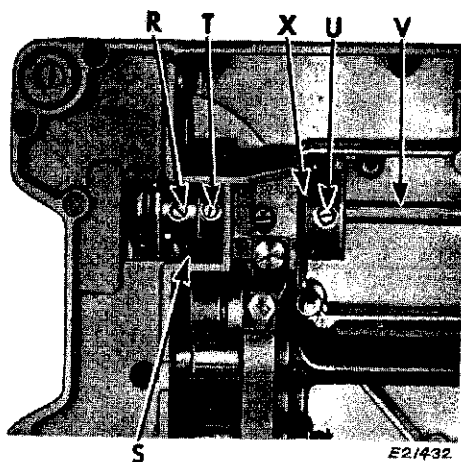

Fig. 9. Removing and Replacing Rotating Hook and Replacing Hook Shaft

TO REPLACE ROTATING HOOK SHAFT

1. Remove presser foot, throat plate, bottom cover plate and rotating hook
2. Loosen screw T, Fig. 9 in shaft collar, and screw U, Fig. 9 in counterbalance so that they slide freely on shaft V, Fig. 9
3. Loosen two screws M, Fig. 8
4. Remove motor hold down plate and motor
5. Unscrew and move two pin terminal W, Fig. 10 out of way so that it will not interfere with replacement of new rotating hook shaft
6. Use new shaft (with flats at left end) to push out old shaft from right to left. Insert new shaft through opening in casting from which two pin terminal was removed. Be sure that end of shaft with two flats (for rotating hook screw R, Fig. 9 and shaft collar T and for counterbalance screw U) is at the left

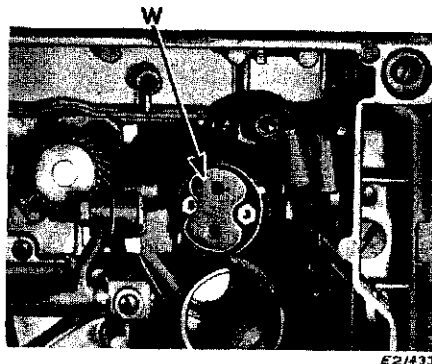

Fig. 10. Two Pin Terminal Removed For Hook Shaft Replacement

TO ADJUST FEED DOG HEIGHT

1. Set stitch regulator at 8 stitches per inch
2. Turn hand wheel over toward you until feed dog is at its highest point
3. Loosen nut N3, Fig. 14 and turn screw P3 to left or to right until teeth of feed dog project .043" above throat plate as shown at Y3, Fig. 13
4. Keeping screw P3 in position with a screwdriver, tighten nut N3, Fig. 14

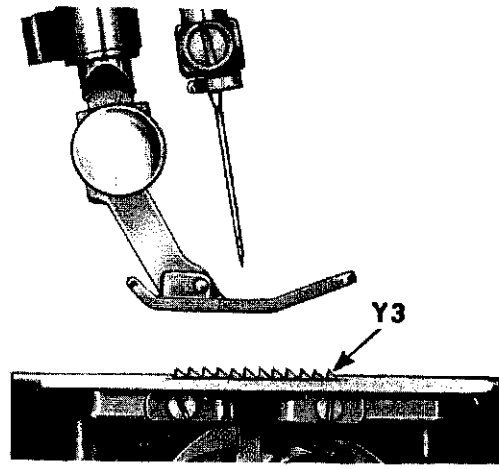

Fig. 13. Correct Height of Feed Dog

TO ADJUST FEED DOG LENGTHWISE IN THROAT PLATE SLOTS

1. Check feed dog height as described above
2. Remove bottom cover plate, motor hold down plate and motor
3. Loosen nut N2, Fig. 14
4. With a screwdriver, turn eccentric stud P2 to adjust lengthwise position of feed dog teeth
5. When proper adjustment has been obtained, hold eccentric stud P2 in position with a screwdriver while tightening nut N2

NOTE: On Machines of Class 301 having a split rock shaft, this adjustment is made by loosening clamping screw Q2, Fig. 15, turning rock shaft R2 until proper feed dog adjustment is obtained, and then tightening clamping screw Q2.

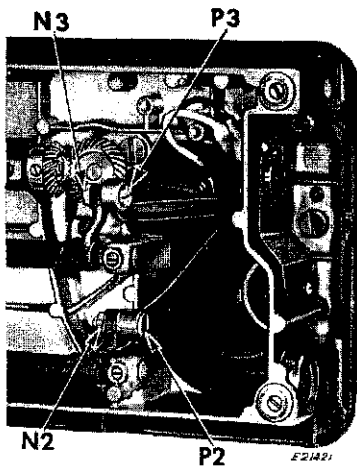

Fig. 14. Adjusting Feed Dog (Machine Having Standard Feed Rock Shaft)

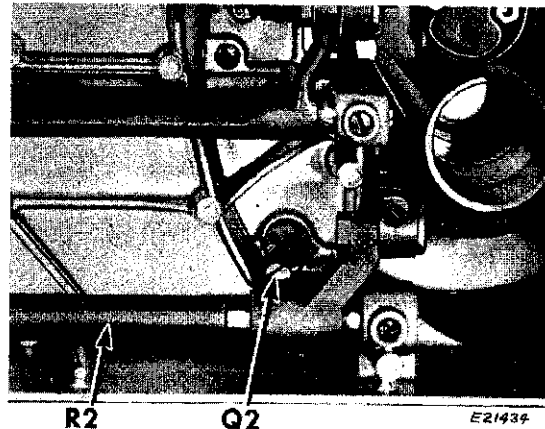

Fig. 15. Adjusting Feed Dog (Machine Having Split Feed Rock Shaft)

TO REGULATE FEED THROW-OUT

To prevent rotating hook from striking feed when feed is inoperative (for darning, embroidering, etc.), feed throw-out must be regulated as described below:

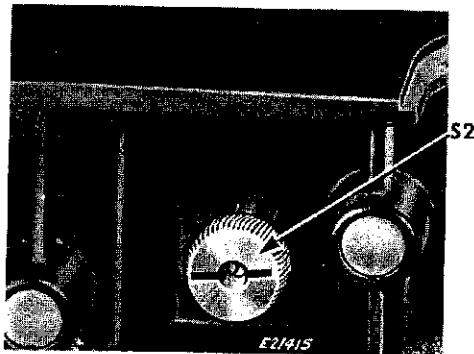

Fig. 16. Regulating Feed Throw-Out Thumb Screw

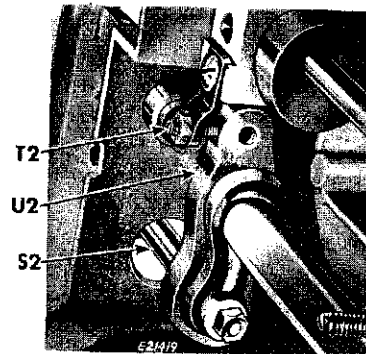

Fig. 17. Regulating Feed Throw-Out Stop Screw

1. Check feed dog height and lengthwise position of feed dog in throat plate as instructed on page 9
2. Set stitch length to longest stitch
3. Turn hand wheel over toward you until feed is at its lowest point
4. Turn feed throw-out thumb screw S2, Fig. 16 clockwise (inwardly), using a screwdriver if necessary, until it is securely tightened
5. Tilt machine back on its rear side and remove bottom cover plate
6. Set feed throw-out stop screw T2, Fig. 17 so that clearance between feed throw-out lever U2, Fig. 17 and stop screw T2 is from .002" to .006"
7. Replace bottom cover plate

TO ADJUST ARM SHAFT FOR CORRECT END PLAY

1. Remove top cover, and loosen set screw V2, Fig. 18 in collar
2. Push collar and crank W2, Fig. 18 toward each other and tighten set screw V2
3. Replace top cover

CAUTION: Be sure that top cover is properly aligned so that it does not bind against presser bar thumb screw, when replacing top cover

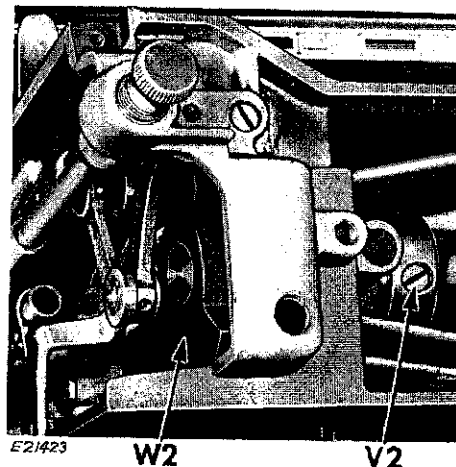

Fig. 18. Adjusting Arm Shaft For Correct End Play

TO ADJUST GEARS FOR CORRECT MESH

1. Remove top cover from machine, and remove oil shield from above the connecting rod
2. Remove screws X2, Fig. 19 to lift cap from connecting rod
3. Loosen set screw Y2, Fig. 20 and adjust to proper gear mesh
4. Tighten screw Y2 and replace connecting rod cap, oil shield and top cover of machine

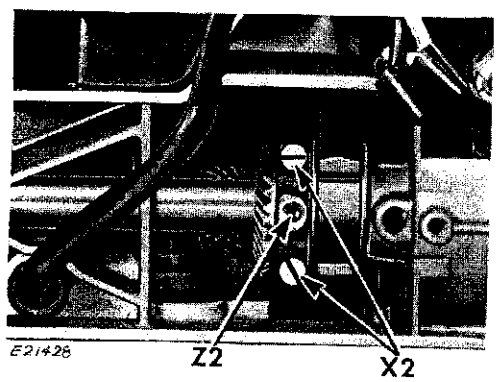

Fig. 19. Removing Connecting Rod Cap

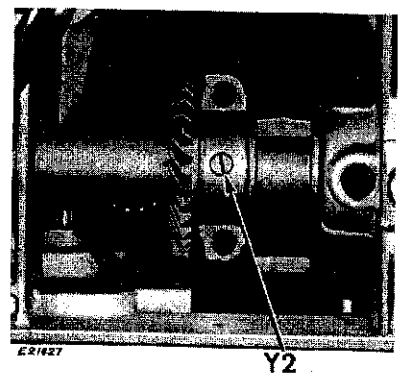

Fig. 20. Adjusting Gears To Correct Mesh

This adjustment can also be made through oil hole Z2, Fig. 19, in connecting rod cap by turning hand wheel over toward you until set screw Y2, Fig. 20 is visible through oil hole Z2. Then insert the proper size screwdriver into hole Z2, loosen screw Y2, make adjustment to correct mesh and retighten screw Y2.

TO REMOVE AND REPLACE BOBBIN WINDER

To remove and disassemble bobbin winder:

1. Remove hand wheel
2. Turn screw A3, Fig. 21 counterclockwise until bobbin winder assembly comes off the machine

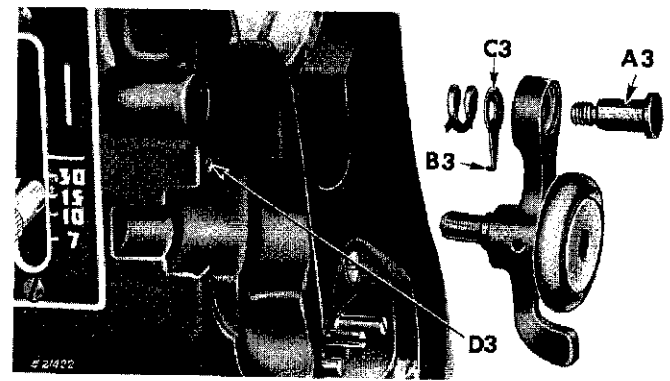

Fig. 21. Bobbin Winder Assembly

To reassemble and replace bobbin winder:

1. Fit parts together in the order indicated in Fig. 21
2. Replace on machine by fitting screw A3 on machine and then tightening screw A3, making sure that right angle projection B3 of stop washer C3 is fitted into hole D3 in casting of machine
3. Replace hand wheel

WIRING DIAGRAM FOR CLASS 301 MACHINE

